



**A Division of VT Specialized Vehicles Corporation**

# Parts Manual

**WASHINGTON, N.C.**  
400 HACKNEY AVE.  
P.O. BOX 880  
WASHINGTON, N.C. 27889



# HACKNEY-PARTS MANUAL

Dear Customer:

This manual, designed specifically for you, contains descriptions and numbers of parts for Hackney, Mickey, Hesse, and Centennial trucks. We encourage you to use it for ordering.

This manual has six main sections: **Parts Common to Bodies and Trailers, Exterior and Interior Parts for Bodies and Trailers, Trailer Parts, Optional Equipment, Miscellaneous Items, and Competitor Parts.** Within these sections are subdivisions with pictures, drawings and parts lists to aid you in identifying the item you need. We also provide measuring instructions when measurements are necessary and a list of raw material numbers for ordering large pieces and cutting them to size.

The Table of Contents will help you locate parts by identifying subdivisions within the manual. An alphabetical index of parts appears at the back for cross-reference purposes.

We hope you find this manual helpful. If you desire to order by fax a form is provided in the back. You may of course call in your order or e-mail it.

**For instructions for safe installation of parts, consult the Hackney Service Manual. If you do not have a Service Manual, you should order one with your parts.**

## **To Order by Fax**

Print one of the forms provided. Fill in the information requested, and fax to Parts Dept. (252) 975-8368

## **To Order On Line**

Log on to web page [www.hackneyparts.com](http://www.hackneyparts.com) then follow the instructions.

## **To Order by Phone**

Call our resident experts toll free direct at (877) 238-7278. (877) BEV-PARTS

# HACKNEY-PARTS MANUAL

## TABLE OF CONTENTS

	Page
<b>Parts Common to Bodies and Trailers</b>	
Door Slat- 5"	2
Door Slat- 3"	3
Door Slat- 2"	4
Door Slat- Bottom New and Old Style	5
Door Slat- Top Rubber and Old Style Felt	6
Door Slat- Top New and Old Style Felt	7
Door Slat- 2.5" Aluminum and Plastic	8
Door Slat- 3" Fingerslot Slat	9
Door Slat- All Raw Material Lengths	10
Counterbalance Parts	11
Counterbalance Asm. For Units Until 1996	12
Counterbalance Asm. For Units 1997 to Current	13
Felt Door Seal	14
Bottom Door Rubber	14
Door Cable	14
Door Rollers	14
Washer- Offset	14
Door Straps	15
Rubber Top Slat Door Seal	15
Rubber Door Stop	15
Footman Door Loop	15
Door Handles	16
Lock Cylinders for Handles	16
Center Case Asm.	16
Combo Door Handles	17
Door Hold Backs	17
Door Keeper	17
Combo Door Seal	17
Combo Rubber Door Stop	17
Aluminum Rear Bumpers	18
Steel Rear Bumpers	19
Aluminum & Steel Rear End/Front Hand Truck Racks	20



**PARTS COMMON TO  
BODIES AND TRAILERS**



**NOTE-** Measure the face of slat to determine if it is a 5", 3", etc.

5" DOOR SLATS						
BAY WIDTH	Slat Width	5" slat	Slat Width	5" slat	Slat Width	5" slat
37	38 5/8	29138	38 3/8	67685	37 7/8	306572
38	39 5/8	29143			38 7/8	306573
40	41 5/8	<i>29151R</i>	41 3/8	<i>91175R</i>	40 7/8	131217
41	42 5/8	29156	42 3/8	62041	41 7/8	306574
42	43 5/8	<i>29169R</i>	43 3/8	91125R	42 7/8	131218
43	44 5/8	<i>29174R</i>	44 3/8	<i>91077R</i>	43 7/8	131219
44	45 5/8	29179	45 3/8	91055	44 7/8	306575
45	46 5/8	29184	46 3/8	91083R	45 7/8	131220
46	47 5/8	29189	47 3/8	91186R	46 7/8	306576
47	48 5/8	29194	48 3/8	73092R	47 7/8	306577
48	49 5/8	29199	49 3/8	91062R	48 7/8	131221
50	51 5/8	29209	51 3/8	67660	50 7/8	306578
51	53 5/8	<i>29224R</i>	53 3/8	68516R	52 7/8	131223
54	55 5/8	29234	55 3/8	69446R	54 7/8	130242
55	56 5/8	29243	56 3/8	73492	55 7/8	306579
56	57 5/8	29248	57 3/8	69734R	56 7/8	130241
57	58 5/8	29253R	58 3/8	69538		
58			59 3/8	67798R		
59	60 5/8	29263	60 3/8	63691R	59 7/8	306580
60	61 5/8	29268	61 3/8	68595	60 7/8	306581
61	62 5/8	<i>29273R</i>	62 3/8	91115	61 7/8	131224
62	63 5/8	29278	63 3/8	68981R	62 7/8	306582
68	69 5/8	29315	69 3/8	64690R	68 7/8	306583

**NOTE-** Slats with a 5/8" pattern were used until 1992. Slats with a 3/8" pattern were used from 1992-1996 and slats with a 7/8" pattern were used from 1996 to current.

**NOTE-** There is exceptions to the slat pattern within the years, especially in change over years. Please measure the slat.

**NOTE-** Part numbers in *italic* are stock.

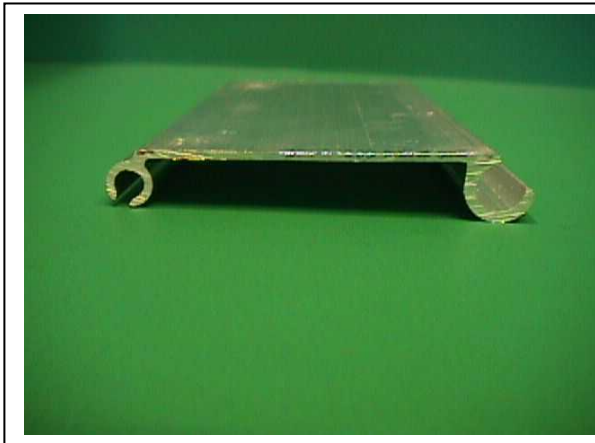

**NOTE-** Measure face of slat to determine if it is a 5", 3", etc.

<b>3" SLATS</b>						
BAY	Slat		Slat		Slat	
WIDTH	Width	3" slat	Width	3" slat	Width	3" slat
37	38 5/8	29139	38 3/8	73296	37 7/8	306584
38	39 5/8	29144			38 7/8	306585
40	41 5/8	<i>29152R</i>	41 3/8	<i>91180R</i>	40 7/8	131230
41	42 5/8	29157	42 3/8	40590	41 7/8	306586
42	43 5/8	<i>29170R</i>	43 3/8	91126R	42 7/8	131231
43	44 5/8	<i>29175R</i>	44 3/8	69498R	43 7/8	131232
44	45 5/8	29180	45 3/8	76360	44 7/8	306587
45	46 5/8	29185	46 3/8	91466	45 7/8	131233
46	47 5/8	29190	47 3/8	73409	46 7/8	306588
47	48 5/8	29195	48 3/8	73093	47 7/8	306589
48	49 5/8	29200	49 3/8	64792	48 7/8	131234
50	51 5/8	29210	51 3/8	78418	50 7/8	306590
51	53 5/8	<i>29225R</i>	53 3/8	91285R	52 7/8	131236
54	55 5/8	29235	55 3/8	69452R	54 7/8	130180
55	56 5/8	29244	56 3/8	77748	55 7/8	306591
56	57 5/8	29249	57 3/8	69735R	56 7/8	130175
57	58 5/8	29254R	58 3/8	73417R		
58			59 3/8	91979R		
59	60 5/8	29264	60 3/8	76450	59 7/8	306592
60	61 5/8	29269	61 3/8	68979	60 7/8	306593
61	62 5/8	<i>29274R</i>	62 3/8	69504R	61 7/8	131237
62	63 5/8	29279	63 3/8	69826	62 7/8	306594
68	69 5/8	29316	69 3/8	64691	68 7/8	306595

**NOTE-** Slats with a 5/8" pattern were used until 1992. Slats with a 3/8" pattern were used from 1992-1996 and slats with a 7/8" pattern were used from 1996 to current.

**NOTE-** There is exceptions to the slat pattern within the years, especially in change over years. Please measure the slat.

**NOTE-** Part numbers in *italic* are stock.



**NOTE-** Measure face of slat to determine if it is a 3", 2", etc.

**2" SLATS**

BAY WIDTH	Slat Width	2" slat	Slat Width	2" slat
37	38 3/8	73480	37 7/8	306596
38			38 7/8	306597
40	41 3/8	<b>91183R</b>	40 7/8	306598
41	42 3/8	94081	41 7/8	306599
42	43 3/8	<b>91453R</b>	42 7/8	131244
43	44 3/8	<b>91244R</b>	43 7/8	131245
44	45 3/8	91056	44 7/8	306600
45	46 3/8	63683	45 7/8	131246
46	47 3/8	91217	46 7/8	306601
47	48 3/8	67869	47 7/8	306602
48	49 3/8	91063R	48 7/8	131247
50	51 3/8	76535R	50 7/8	306603
51	53 3/8	68517R	52 7/8	131249
54	55 3/8	69806	54 7/8	306604
55	56 3/8	75928	55 7/8	306605
56	57 3/8	73040	56 7/8	306606
57	58 3/8	73678R		
58	59 3/8	79227R		
59	60 3/8	63692R	59 7/8	306607
60	61 3/8	68596	60 7/8	306608
61	62 3/8	91507R	61 7/8	131250
62	63 3/8	91052R	62 7/8	306609

**NOTE-** Slats with a 5/8" pattern were used until 1992. Slats with a 3/8" pattern were used from 1992-1996 and slats with a 7/8" pattern were used from 1996 to current.

**NOTE-** There is exceptions to the slat pattern within the years, especially in change over years. Please measure slats.

**NOTE-** Part numbers in *italic* are stock.

68	69 3/8	64692R	68 7/8	306610
----	--------	--------	--------	--------

## HACKNEY-PARTS MANUAL

## PAGE-5



Old Style- Used Prior to 1996. 5/8 & 3/8 Pattern Slats.



New Style- Used 1997 to Current. 7/8 Pattern Slats.

**NOTE-** The bottom slats with hardware include a cable, strap, bottom door seal, and 2 rollers and a footman loop.

**NOTE-** See pictures to left to determine which type of bottom slat you have.

BOTTOM SLAT 2.5"									
BAY	Slat	Btm		Slat	Btm		Slat	Btm	
WIDTH	Width	slat	BHWC	Width	slat	BHWC	Width	slat	BHWC
37	38 5/8	29142	12690	38 3/8	67687		37 7/8	306527	306507
38	39 5/8	29146					38 7/8	306528	306508
40	41 5/8	<i>29155R</i>	<i>10384R</i>	41 3/8	<i>91177R</i>	96143R	40 7/8	129617	306509
41	42 5/8	29160	11209	42 3/8	62043		41 7/8	306529	306510
42	43 5/8	29173	11207	43 3/8	91128R	94653R	42 7/8	129615	306511
43	44 5/8	29178	16606	44 3/8	<i>91079R</i>	108492	43 7/8	131268	306512
44	45 5/8	29183	11205	45 3/8	91058		44 7/8	306530	306513
45	46 5/8	29188	11211	46 3/8	91085R	108479K	45 7/8	131269	306514
46	47 5/8	29193	11213	47 3/8	91188	323403	46 7/8	306531	306515
47	48 5/8	29198	11215	48 3/8	73095		47 7/8	306532	306516
48	49 5/8	29203	11217	49 3/8	91065R	95279R	48 7/8	129608	306517
50	51 5/8	29213	11219	51 3/8	67662	103340	50 7/8	306533	306518
51	53 5/8	<i>29228R</i>	10887	53 3/8	68520R	90322R	52 7/8	124640	307453
54	55 5/8	29238	12861	55 3/8	69448R	95979R	54 7/8	130178	306519
55	56 5/8	29247	11221	56 3/8	73494	306972	55 7/8	306534	306520
56	57 5/8	29252	11223	57 3/8	69737R	94642R	56 7/8	130173	306521
57	58 5/8	29257R	323554	58 3/8	69540	103759K			
58				59 3/8	67800				
59	60 5/8	29267	11229	60 3/8	63700R	119063K	59 7/8	306535	306522
60	61 5/8	29272	11225	61 3/8	94876	117491K	60 7/8	306536	306523
61	62 5/8	29277	10889	62 3/8	91117R	102158R	61 7/8	131271	306524
62	63 5/8	29282	<i>11227R</i>	63 3/8	68983R	95178R	62 7/8	306537	306525
68	69 5/8	29318	11233	69 3/8	64694	110460K	68 7/8	306538	306526

**NOTE-** Slats with a 5/8" pattern were used until 1992. Slats with a 3/8" pattern were used from 1992-1996 and slats with a 7/8" pattern were from 1996 to current.

**NOTE-** There is exceptions to the slat pattern within the years, especially in change over years. Please measure the slat.

**NOTE-** Part numbers in *italic* are stock.

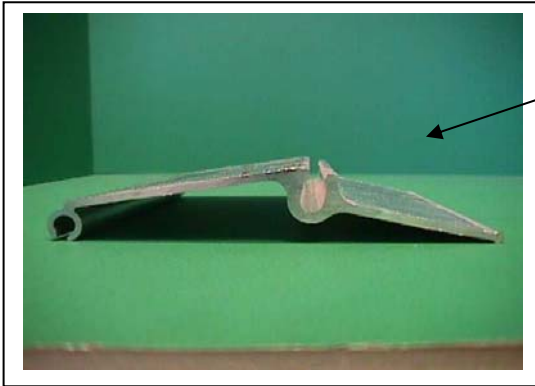

Rubber Style

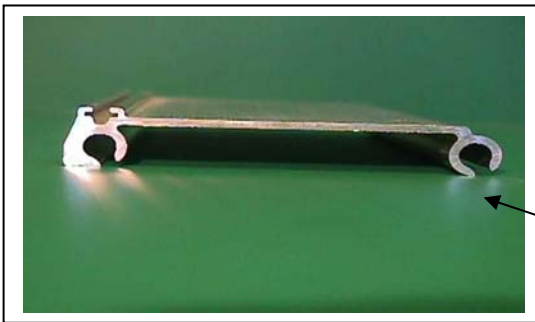

Old Style- Felt

**NOTE-** On top slats with 5/8" pattern please specify whether it has rubber or felt seal.

**NOTE-** On top slats with 5/8" pattern, the top slat with hardware comes with the rubber seal and 2 rollers.  
(On 5/8 pattern the top slat with hardware is the rubber top slat)

**NOTE-** See pictures to left to determine which type of top slat you have.

**5/8" Pattern Top Door Slats**

BAY WIDTH	Slat Width	Top (r)	Top (f)	THWC
37	38 5/8	29140	29136	
38	39 5/8	29145	29141	
40	41 5/8	29153	29154	10064
41	42 5/8	29158	29159	11208
42	43 5/8	29171	<i>29172R</i>	11206
43	44 5/8	29176	<i>29177R</i>	16607
44	45 5/8	29181	29182	11204
45	46 5/8	29186	29187	11210
46	47 5/8	29191	29192	11212
47	48 5/8	29196	29197	11214
48	49 5/8	29201	29202	11216
50	51 5/8	29211	29212	11218
51	53 5/8	29226	29227	10397
54	55 5/8	29236	29237	12862
55	56 5/8	29245	29246	11220
56	57 5/8	29250	29251	11222
57	58 5/8	29225R	29256R	
58				
59	60 5/8	29265	29266	11228
60	61 5/8	29270	29271	11224
61	62 5/8	29275	29276	10888
62	63 5/8	29280	29281	11226
68	69 5/8	29317	37362	11232

**NOTE-** Slats with a 5/8" pattern were used until 1992. Slats with a 3/8" pattern were used from 1992-1996 and slats with a 7/8" pattern were used from 1996 to current.

**NOTE-** There is exceptions to the slat pattern within the years, especially in change over years. Please measure the slat.

**NOTE-** Part numbers in *italic* are stock.

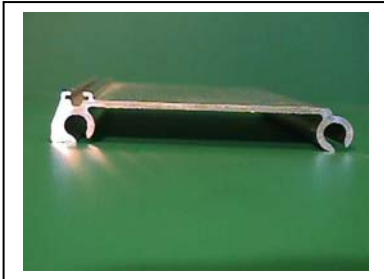

Old style- Used prior to 1996, 3/8 patter slats

**NOTE-** The top slats with hardware come with felt seal and 2 rollers.

**NOTE-** See pictures to left to determine which top slat you have.



New Style- Used 1997 to current, 7/8 pattern slat.

**3/8" and 7/8" Pattern Top Slats**

Slat Width	TOP	THWC	Slat Width	TOP	THWC
38 3/8	67686	126476	37 7/8	306560	306539
			38 7/8	306561	306540
41 3/8	<i>91176R</i>	95902	40 7/8	131256	306541
42 3/8	40591		41 7/8	306562	306542
43 3/8	91127R	94654	42 7/8	131257	306543
44 3/8	91078	315028	43 7/8	131258	306544
45 3/8	91057		44 7/8	306563	306545
46 3/8	91084R		45 7/8	131259	306546
47 3/8	91187		46 7/8	306564	306547
48 3/8	73094		47 7/8	306565	306548
49 3/8	91064	105654	48 7/8	131260	306549
51 3/8	67661R	315029	50 7/8	306566	306550
53 3/8	68519R	126477	52 7/8	131262	306551
55 3/8	69447R	90103	54 7/8	130179	306552
56 3/8	73493	306971	55 7/8	306567	306553
57 3/8	69736	323169	56 7/8	130174	306554
58 3/8	<i>69539R</i>				
59 3/8	67799R				
60 3/8	63699R		59 7/8	306568	306555
61 3/8	68598R		60 7/8	306569	306556
62 3/8	91116R		61 7/8	131263	306557
63 3/8	68982		62 7/8	306570	306558
69 3/8	64693R		68 7/8	306571	306559

**NOTE-** Slats with a 5/8" pattern were used until 1992. Slats with a 3/8" pattern were used from 1992-1996 and slats with a 7/8" pattern were used from 1996 to current.

**NOTE-** There is exceptions to the slat pattern within the years, especially in change over years. Please measure the slat.

**NOTE-** Part numbers in *italic* are stock.



2.5" Aluminum

**NOTE-** The 2.5" aluminum slat replaces the plastic slat.

**NOTE-** Look at pictures to left to compare.



2.5" Plastic

2.50" ALUMINUM		2.5" PLASTIC SLATS			
	PART	DESCRIPTION	PART	DESCRIPTION	PART
DESCRIPTION	NUMBER		NUMBER		NUMBER
		2.50X27.19	122979	2.50X52.81	302746
2.50X40.88	315284	2.50X35.31	127318	2.50X53.31	122981
2.50X41.38	302913	2.50X40.81	130170	2.50X53.38	995701
2.50X43.38	312342	2.50X41.31	126710	2.50X54.81	130177
2.50X49.38	124728	2.50X41.38	995711	2.50X55.31	124726
2.50X52.88	302747	2.50X42.81	315026	2.50X56.31	302752
2.50X54.88	315834	2.50X43.31	312341	2.50X56.81	130172
2.50X55.38	124729	2.50X43.38	995702	2.50X57.31	126703
2.50X56.88	302753	2.50X46.81	315027	2.50X58.31	312348
2.50X58.38	312349	2.50X49.31	124723	2.50X58.38	114373
		2.50X52.31	127313		

**NOTE-** Slats with a 5/8" pattern were used until 1992. Slats with a 3/8" pattern were used from 1992-1996 and slats with a 7/8" pattern were from 1996 to current.

**NOTE-** There is exceptions to the slat pattern within the years, especially in change over years. Please measure the slats.

**NOTE-** None of these slats are stock.



**NOTE-** The finger slot is our new current standard. If you have a trailer or body that does not have the finger slot and you would like to have them, next measure the slats you have, then order one finger slot and one 2" slat to replace a 5" slat already in your door.

**NOTE-** See picture to left for finger slot.

3" FINGERSLOT SLATS			
DESCRIPTION	PART NUMBER	DESCRIPTION	PART NUMBER
3.00X37.88	302494	3.00X48.88	131276
3.00X40.88	131273	3.00X48.88	131277
3.00X41.38	126711	3.00X49.38	124724
3.00X41.62	306404	3.00X49.88	131278
3.00X42.88	131274	3.00X52.88	131279
3.00X43.38	312343	3.00X53.38	130051
3.00X43.88	131275	3.00X53.62	312033
3.00X44.38	130269	3.00X68.62	315084
3.00X44.62	312032		

**NOTE-** Slats with a 5/8" pattern were used until 1992. Slats with a 3/8" pattern were used from 1992-1996 and slats with a 7/8" pattern were used from 1996 to current.

**NOTE-** There is exceptions to the slat pattern within the years, especially in change over years. Please measure the slat.

**NOTE-** These slats are not stock

## RAW MATERIAL SLAT LENGTHS

<b>PART #</b>	<b>DISCRIPTION</b>	<b>LENGTH</b>	<b>DRAWING #</b>
807058	5" DOOR SLAT	138.25"	D-85S-042B
3435	5" DOOR SLAT	167.25"	D-85S-042B
3533	3" DOOR SLAT	216.00"	D-85S-041B
65319	2" DOOR SLAT	216.00"	D-89S-107A
803315	TOP SLAT NEW STYLE	216.00"	PTC0169B
803337	BOTTOM SLAT NEW STYLE	216.00"	PTC0168A
802125	TOP SLAT OLD STYLE	216.00"	D-85B-114B
802126	BOTTOM SLAT OLD STYLE	216.00"	D-85S-029B
803375	2.5" ALUMINUM SLAT	216.00"	PTC0170B
83841	5" HEAVY DUTY SLAT	216.00"	D-85S-040B
3488	TOP SLAT-RUBBER STYLE	167.25"	D-85S-030D
803161	3" FINGERSLOT SLAT	216.00"	D-95B-250
802428	2.5" PLASTIC SLAT	216.00"	D-93B-227A

**COUNTERBALANCE PARTS**

COUNTERBALANCE					
SINGLE SPRING					
BAY	ASM	1" TUBE	BAY	ASM	1" TUBE
WIDTH	NUMBER	LENGTH	WIDTH	NUMBER	LENGTH
20	40874	22.62	56	40912	58.62
21	40875	23.62	57	40913	59.62
22	119108	24.62	58	40914	60.62
23	40876	25.62	59	40915	61.62
24	40877	26.62	60	40916	62.62
25	40878	27.62	61	40917	63.62
26	40879	28.62	62	40918	64.62
27	N/A	29.62	63	40919	65.62
28	40880	30.62	64	40921	66.62
29	40881	31.62	DOUBLE SPRING		
30	40882	32.62	COUNTERBALANCE		
31	40883	33.62	65	40924	67.62
32	40884	34.62	66	40925	68.62
33	40885	35.62	67	40926	69.62
34	40886	36.62	68	40927	70.62
35	N/A	37.62	69	40928	71.62
36	40887	38.62	70	40929	72.62
37	40888	39.62	71	40930	73.62
38	40889	40.62	72	40931	74.62
39	40890	41.62	73	40932	75.62
40	40891	42.62	74	40933	76.62
41	40893	43.62	75	40934	77.62
42	40896	44.62	76	40935	78.62
43	40897	45.62	77	40936	79.62
44	40945	46.62	78	40937	80.62
45	40899	47.62	79	40938	81.62
46	40900	48.62	80	40939	82.62
47	40901	49.62	81	40940	83.62
48	40902	50.62	82	111475	84.62
48	40903	51.62	83	40941	85.62
50	40904	52.62	84	103125	86.62
51	40906	53.62	85	40942	87.62
52	40907	54.62	86	N/A	88.62
53	40908	55.62	87	40943	89.62
54	40909	56.62	88	N/A	90.62
55	40911	57.62	89	106158	91.62

**NOTE-** Counterbalances that are .62" long were used until 1996

COUNTERBALANCE					
----------------	--	--	--	--	--

SINGLE SPRING					
BAY	ASM	1" TUBE	BAY	ASM	1" TUBE
WIDTH	NUMBER	LENGTH	WIDTH	NUMBER	LENGTH
20	131722	22.12	56	131704	58.12
21	131724	23.22	57	131706	59.12
22	131726	24.22	58	132331	60.12
23	131728	25.22	59	131710	61.12
24	131730	26.22	60	131495	62.12
25	131083	27.22	61	116691	63.12
26	131112	28.22	62	131708	64.12
27	N/A	29.22	63	131712	65.12
28	130263	30.22	64	131714	66.12
29	131734	31.22	DOUBLE SPRING		
30	131736	32.22	COUNTERBALANCE		
31	131738	33.22	65	130265	67.12
32	124581	34.22	66	131742	68.12
33	131740	35.22	67	131120	69.12
34	131732	36.22	68	131744	70.12
35	N/A	37.22	69	131746	71.12
36	131432	38.12	70	131582	72.12
37	131716	39.12	71	131748	73.12
38	131718	40.12	72	131750	74.12
39	131720	41.12	73	131752	75.12
40	129596	42.12	74	129598	76.12
41	131692	43.12	75	131754	77.12
42	129603	44.12	76	131756	78.12
43	131114	45.12	77	130246	79.12
44	131694	46.12	78	131758	80.12
45	131116	47.12	79	131760	81.12
46	132032	48.12	80	131762	82.12
47	131696	49.12	81	131764	83.12
48	129601	50.12	82	131766	84.12
49	131073	51.12	83	131768	85.12
50	131698	52.12	84	131770	86.12
51	131700	53.12	85	131772	87.12
52	131118	54.12	86	N/A	88.12
53	130274	55.12	87	131774	89.12
54	131671	56.12			
55	131702	57.12			

**NOTE-** Counterbalances that are .12" and .22" long were used from 1996 to current.

